

IMPORTANT DESIGN NOTE: ALL DEGS, DESIGNS, ARRANGEMENTS AND PLANS INDICATED OR REPRESENTED BY THESE DRAWINGS ARE OWNED BY AND THE PROPERTY OF PRL GLASS SYSTEMS INC. NO PART THEREOF SHALL BE REPRODUCED, COPIED, ADAPTED, DISTRIBUTED TO OTHERS, PUBLISHED, SOLD OR OTHERWISE USED WITHOUT THE PRIOR WRITTEN CONSENT OF AND APPROPRIATE COMPENSATION TO PRL GLASS SYSTEMS INC. COPYRIGHT ©

ARCHITECT OF RECORD'S APPROVAL	
STRUCTURAL ENGINEER OF RECORD'S APPROVAL	
STRUCTURAL ENGINEER'S APPROVAL	
GENERAL CONTRACTOR'S APPROVAL	
REVISIONS	BY
▲	
▲	
▲	
▲	
▲	
job name job name job name  address  GENERAL CONTRACTOR:    ARCHITECT: XXXXXXXXXXXX    XXXXXXXXXXXX	
DATE: April, 17, 2014 SCALE: 1"=X'-X" DRAWN: P JOB: XXXXXXXX SHEET:	

**PRL** GLASS SYSTEMS INC.  
 Telephone : (877) 775-25856    251 Mason Way  
 Fax No. : (626) 968-95256    City of industry, C.A.  
 www.prl.glass.com    www.prlaluminum.com

## Max Slider: Sliding Glass Door - Medium Stile - MS / NS / MS

### Sliding Door / Fixed Panel ( XXO )

THE DRAWING IS NOT TO SCALE IF NOT PRINTED ON 24" X 36" PAPER

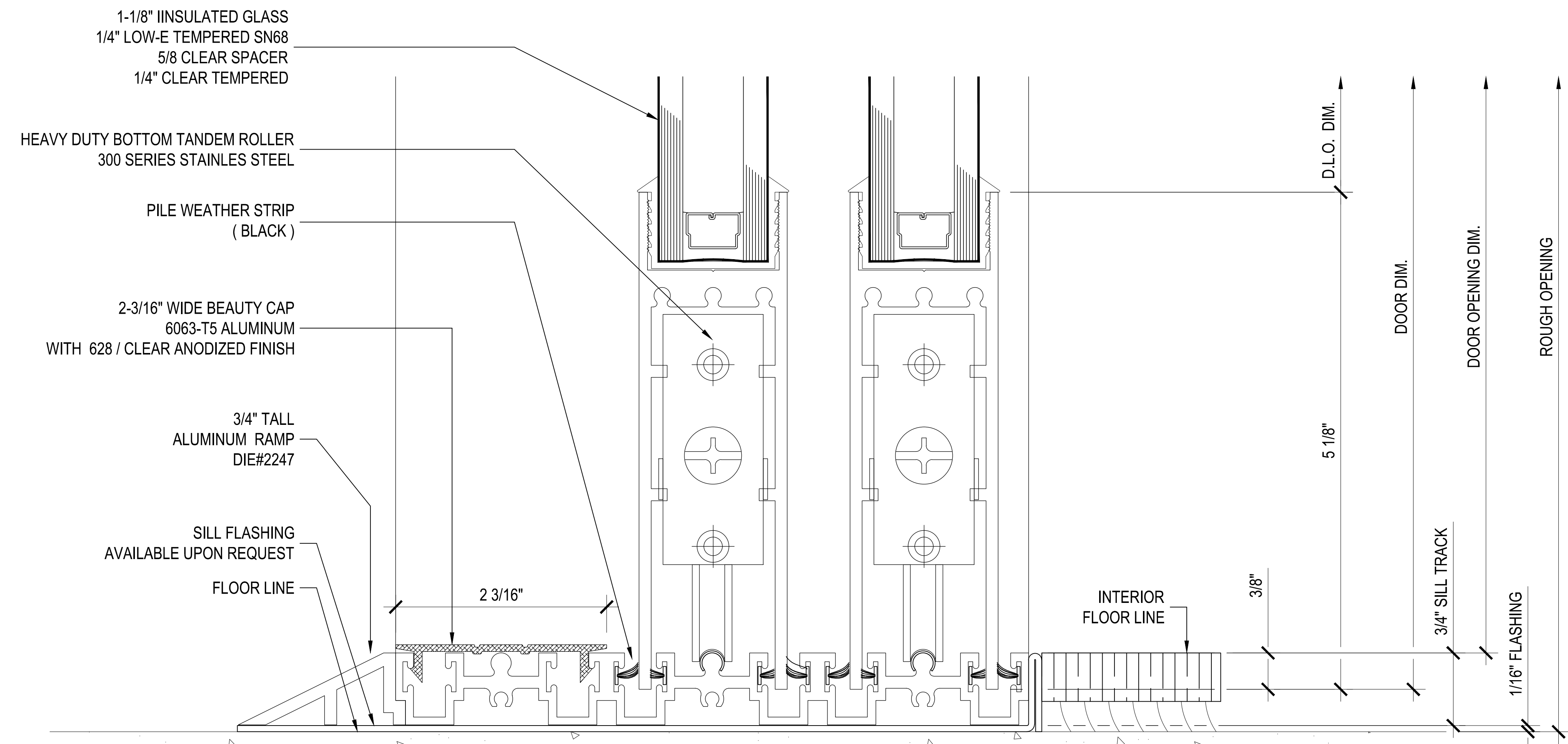
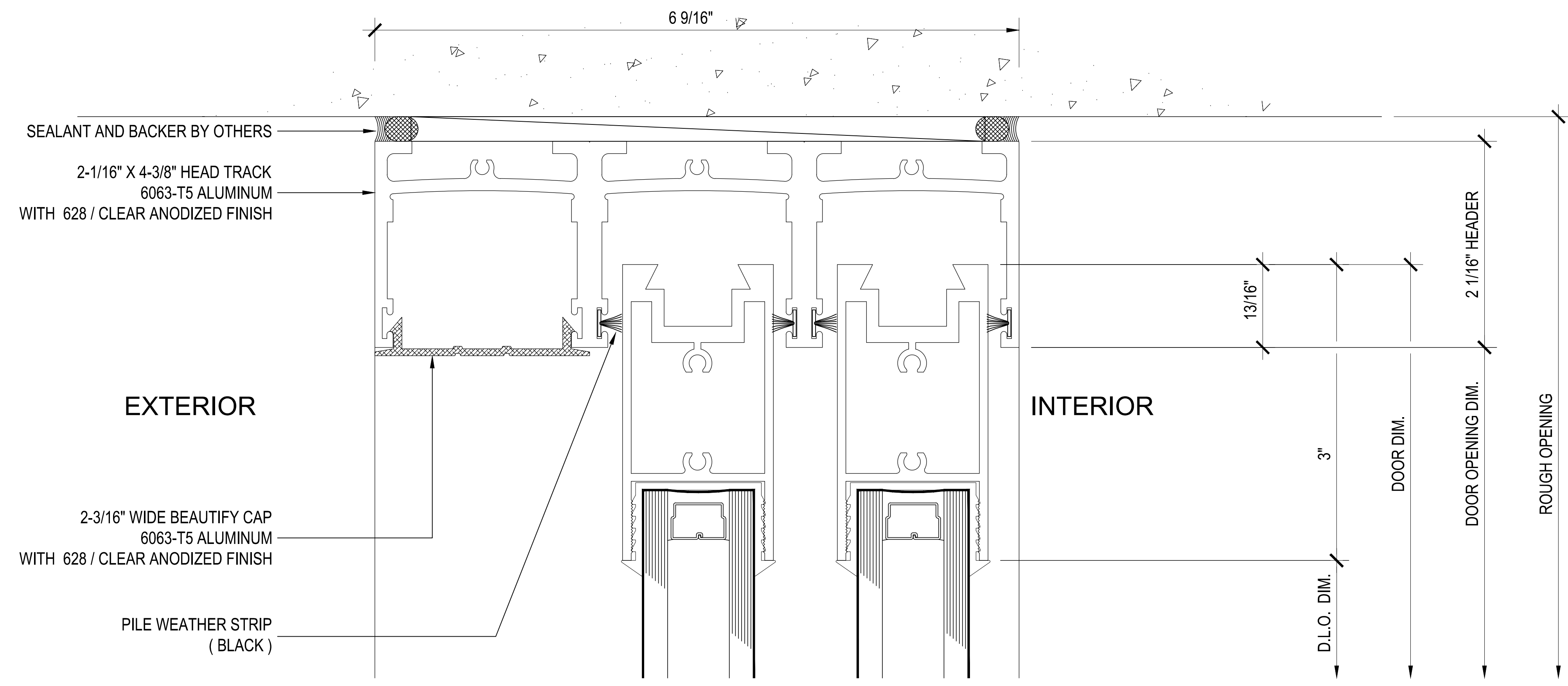

**C** Section @ (Slider)  
Max-Slider Sliding Glass Door (XXO)

IMPORTANT DESIGN NOTE: ALL IDEAS, DESIGNS, ARRANGEMENTS AND PLANS INDICATED OR REPRESENTED BY THESE DRAWINGS ARE OWNED BY AND THE PROPERTY OF PRL GLASS SYSTEMS INC. NO PART THEREOF SHALL BE REPRODUCED, COPIED, ADAPTED, DISTRIBUTED TO OTHERS, PUBLISHED, SOLD OR OTHERWISE USED WITHOUT THE PRIOR WRITTEN CONSENT OF AND APPROPRIATE COMPENSATION TO PRL GLASS SYSTEMS INC. COPYRIGHT ©

THE DRAWING IS NOT TO SCALE IF NOT PRINTED ON PAPER

ALL IDEAS, DESIGNS, ARRANGEMENTS AND PLANS INDICATED OR REPRESENTED BY THESE DRAWINGS ARE OWNED BY AND THE PROPERTY OF PRL GLASS SYSTEMS INC. NO PART THEREOF SHALL BE REPRODUCED, COPIED, ADAPTED, DISTRIBUTED TO OTHERS, PUBLISHED, SOLD OR OTHERWISE USED WITHOUT THE PRIOR WRITTEN CONSENT OF AND APPROPRIATE COMPENSATION TO PRL GLASS SYSTEMS INC. COPYRIGHT ©

THE DRAWING IS NOT TO SCALE IF NOT PRINTED ON PAPER

ARCHITECT OF RECORD'S APPROVAL

STRUCTURAL ENGINEER OF RECORD'S APPROVAL

STRUCTURAL ENGINEER'S APPROVAL

GENERAL CONTRACTOR'S APPROVAL

REVISIONS	BY

job name  
 job name  
 job name  
 address

GENERAL CONTRACTOR: XXXXXXXX ARCHITECT: XXXXXXXX

DATE: March, 21, 2014  
 SCALE: XXXXX  
 DRAWN: P  
 JOB: XXXXXXXX  
 SHEET:

2.01

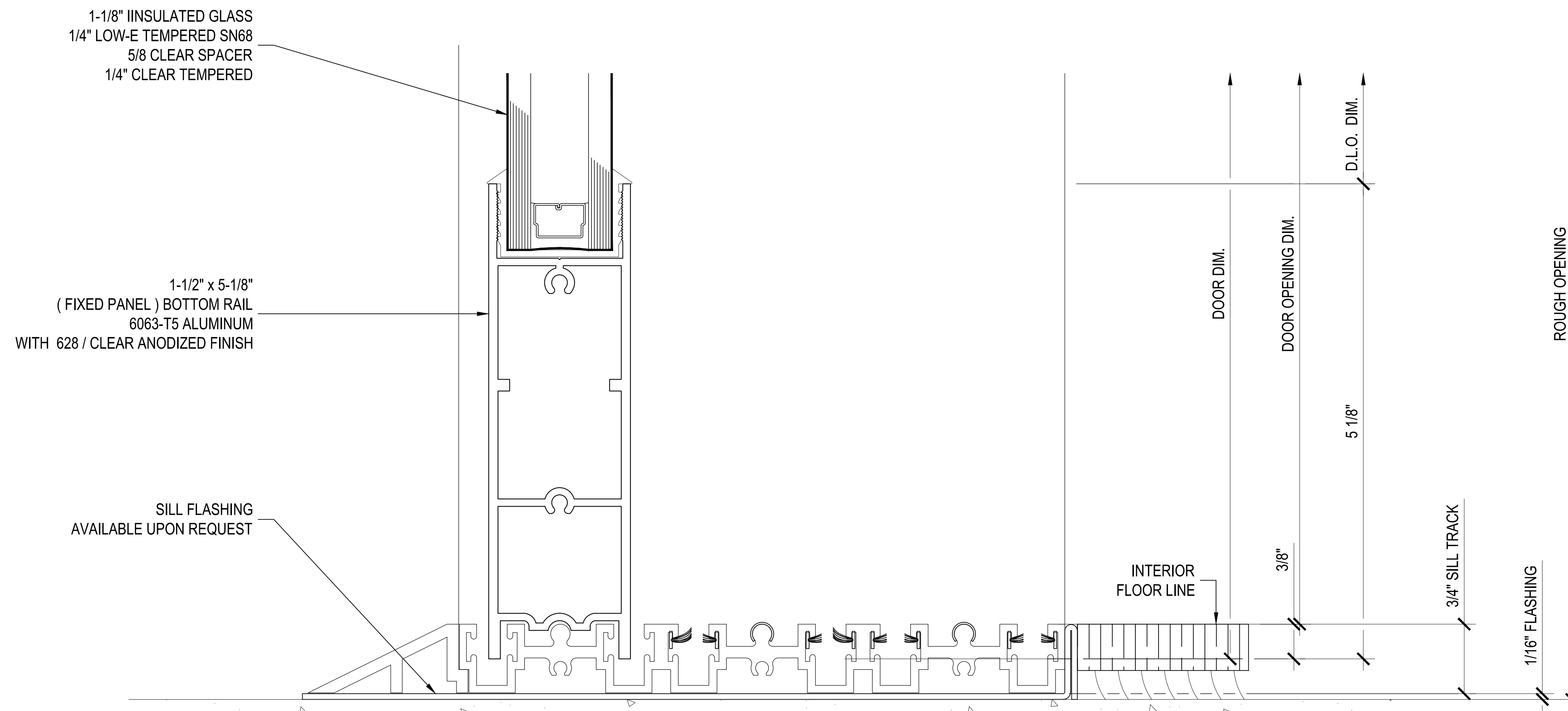
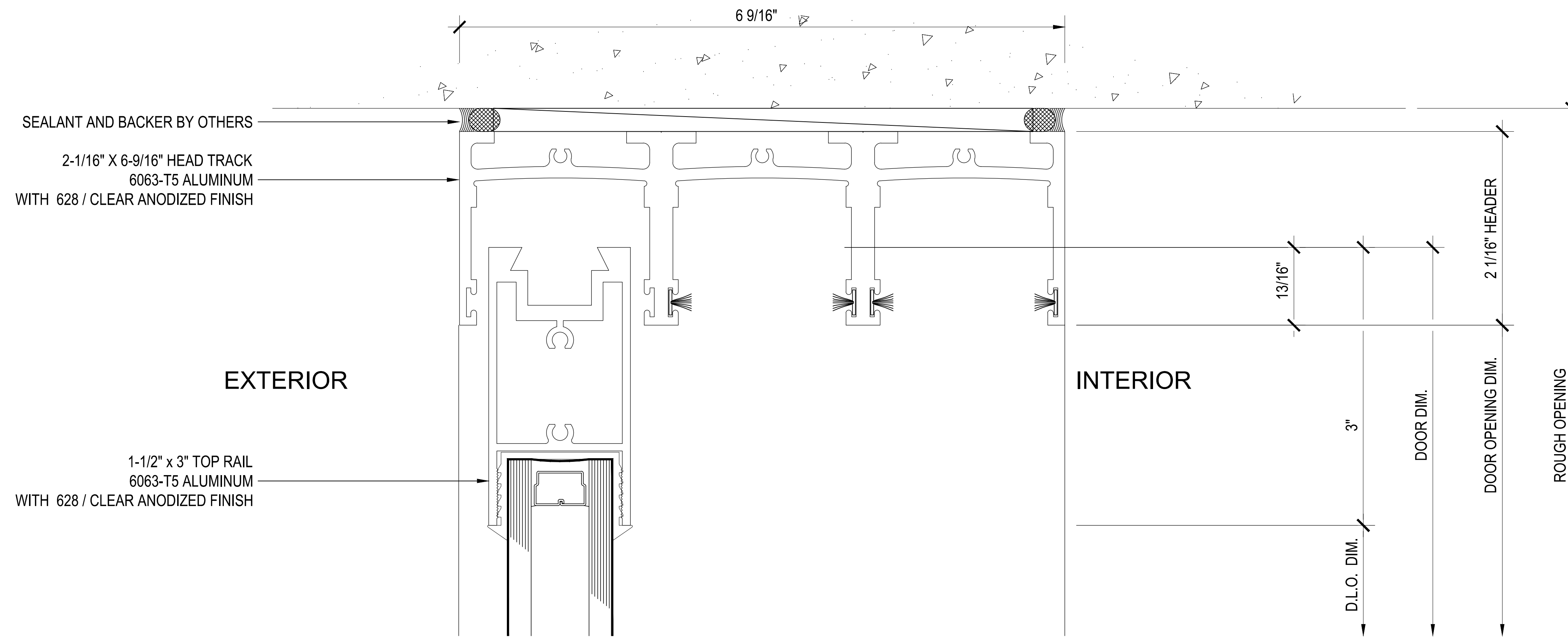

**B** Section @ (Fixed)  
Max-Slider Sliding Glass Door (XXO)

IMPORTANT DESIGN NOTE: ALL IDEAS, DESIGNS, ARRANGEMENTS AND PLANS INDICATED OR REPRESENTED BY THESE DRAWINGS ARE OWNED BY AND THE PROPERTY OF PRL GLASS SYSTEMS INC. NO PART THEREOF SHALL BE REPRODUCED, COPIED, ADAPTED, DISTRIBUTED TO OTHERS, PUBLISHED, SOLD OR OTHERWISE USED WITHOUT THE PRIOR WRITTEN CONSENT OF PRL GLASS SYSTEMS INC. COPYRIGHT ©

ARCHITECT OF RECORD'S APPROVAL

STRUCTURAL ENGINEER OF RECORD'S APPROVAL

STRUCTURAL ENGINEER'S APPROVAL

GENERAL CONTRACTOR'S APPROVAL

REVISIONS	BY
△	
△	
△	
△	
△	

job name  
 job name  
 job name  
 address

GENERAL CONTRACTOR: XXXXXXXX ARCHITECT: XXXXXXXX

DATE: March, 21, 2014  
 SCALE: XXXXXX  
 DRAWN: P  
 JOB: XXXXXXXX  
 SHEET:

**3.01**

THE DRAWING IS NOT TO SCALE IF NOT PRINTED ON 24" X 36" PAPER

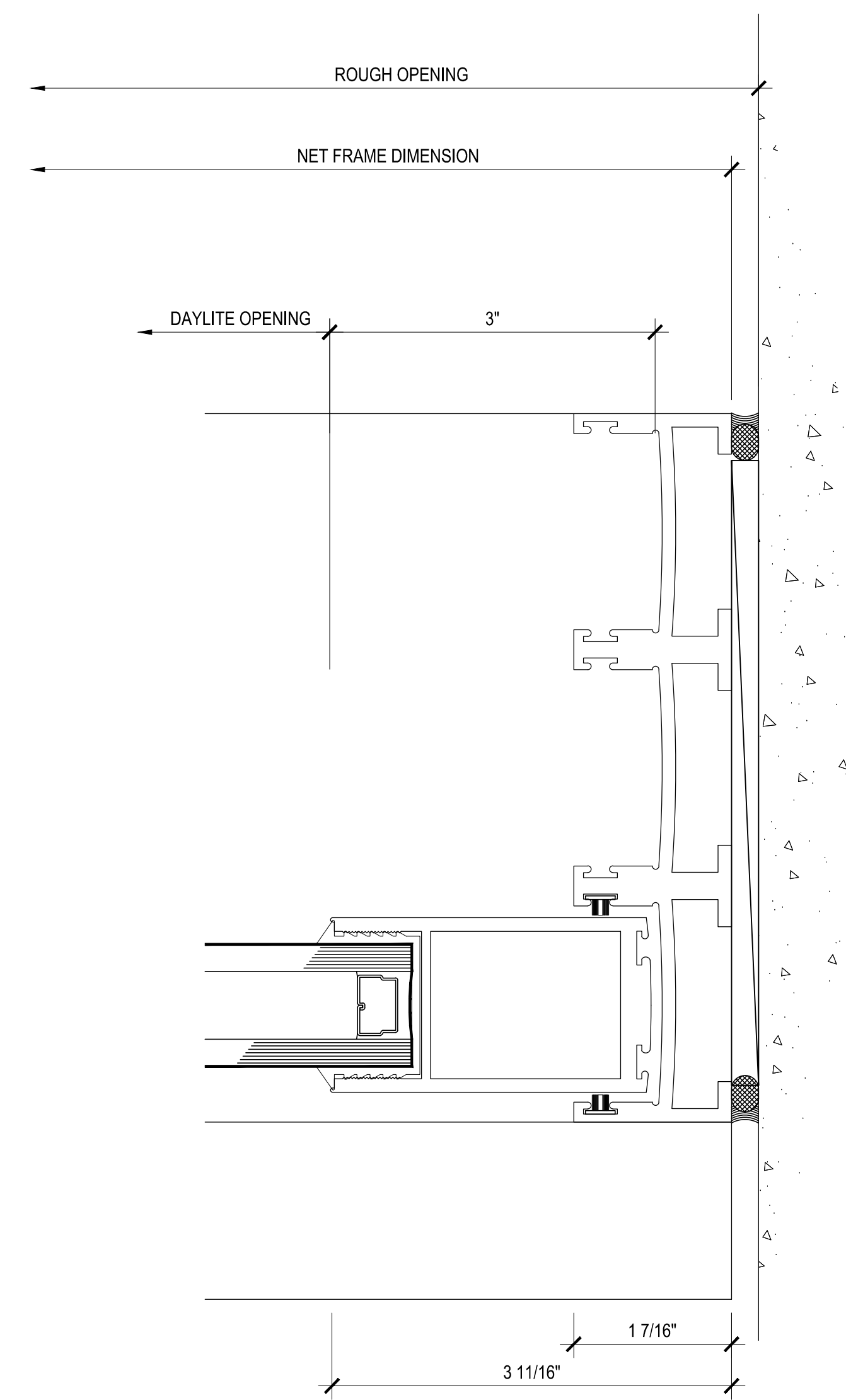
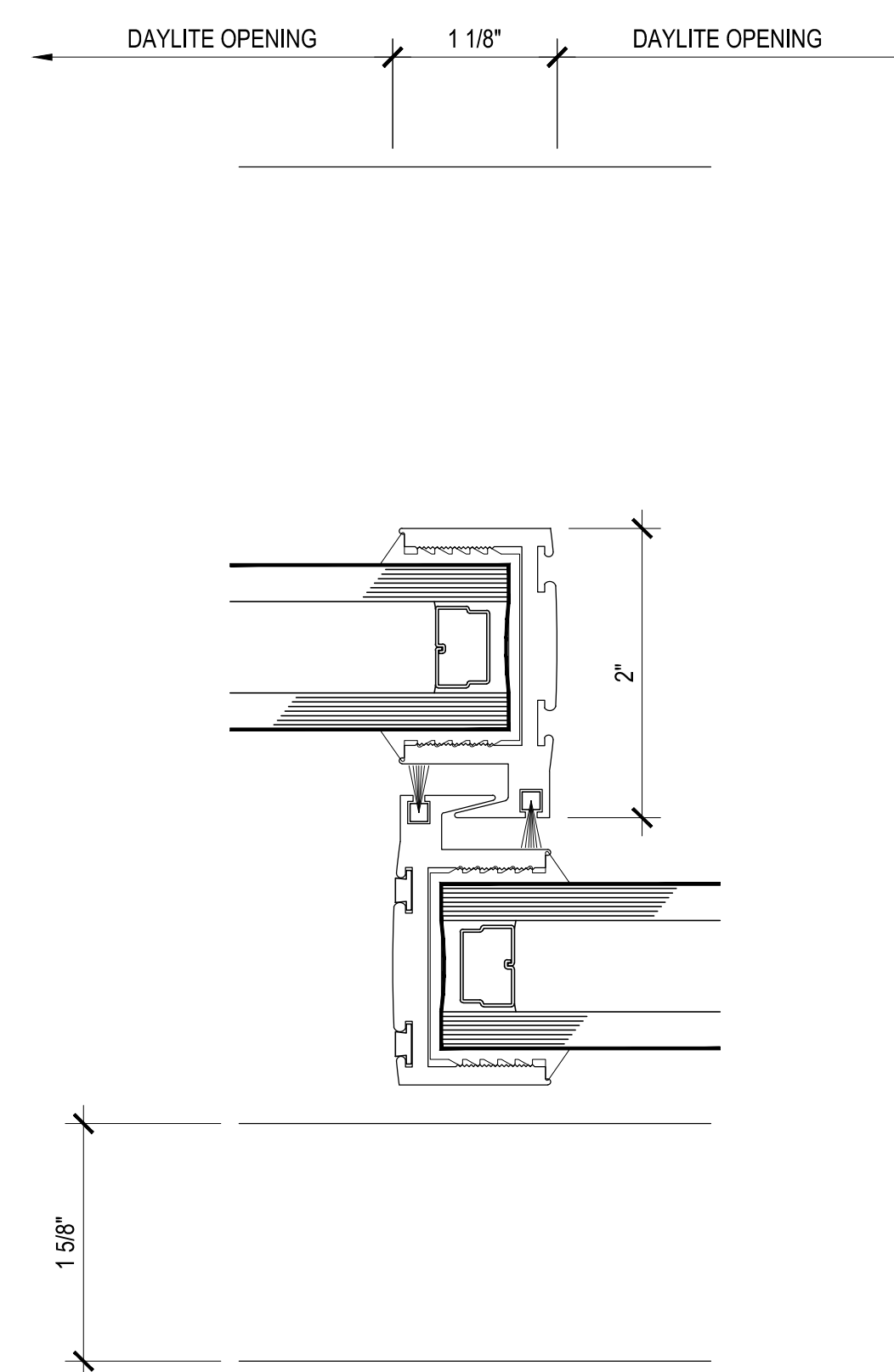
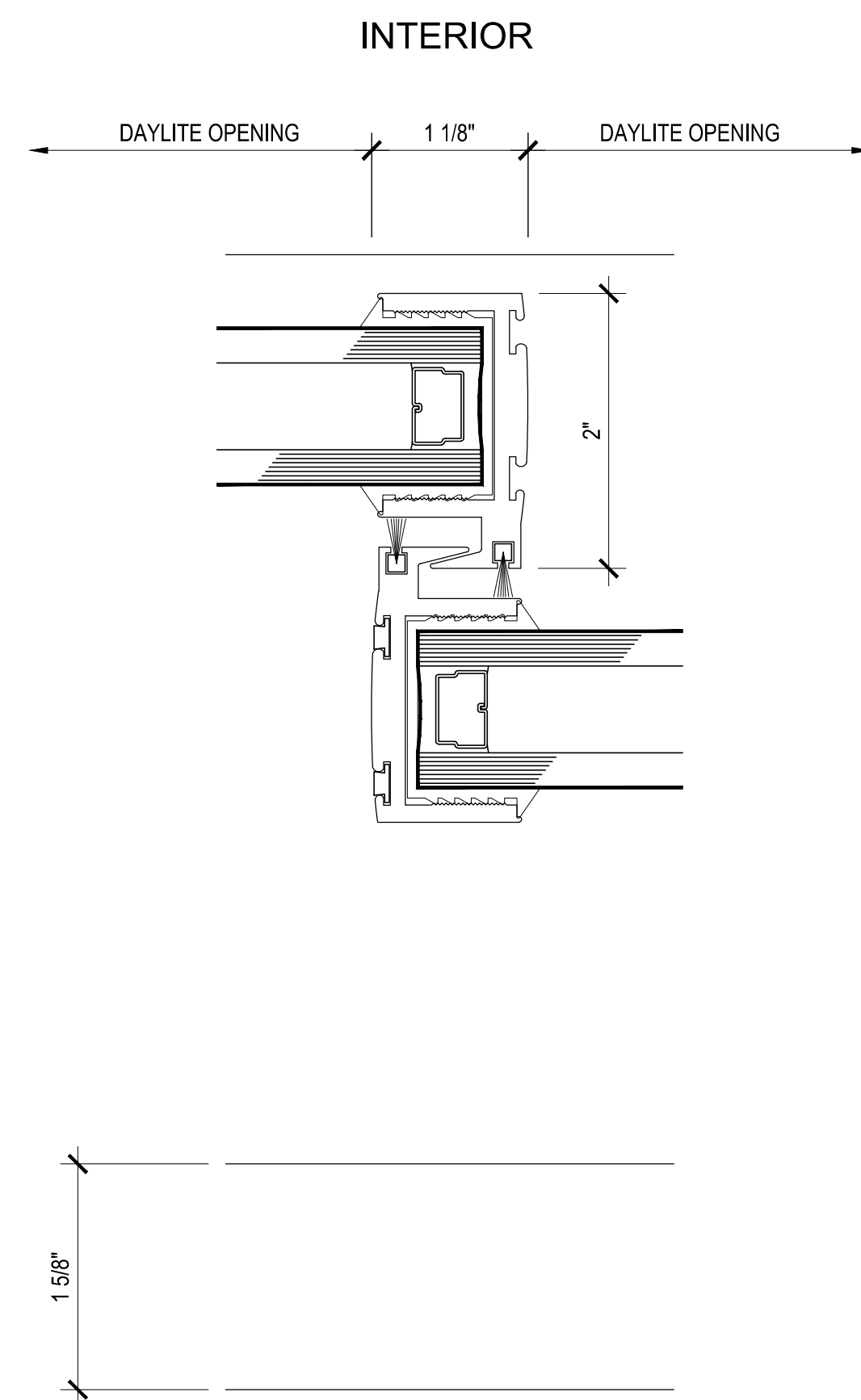
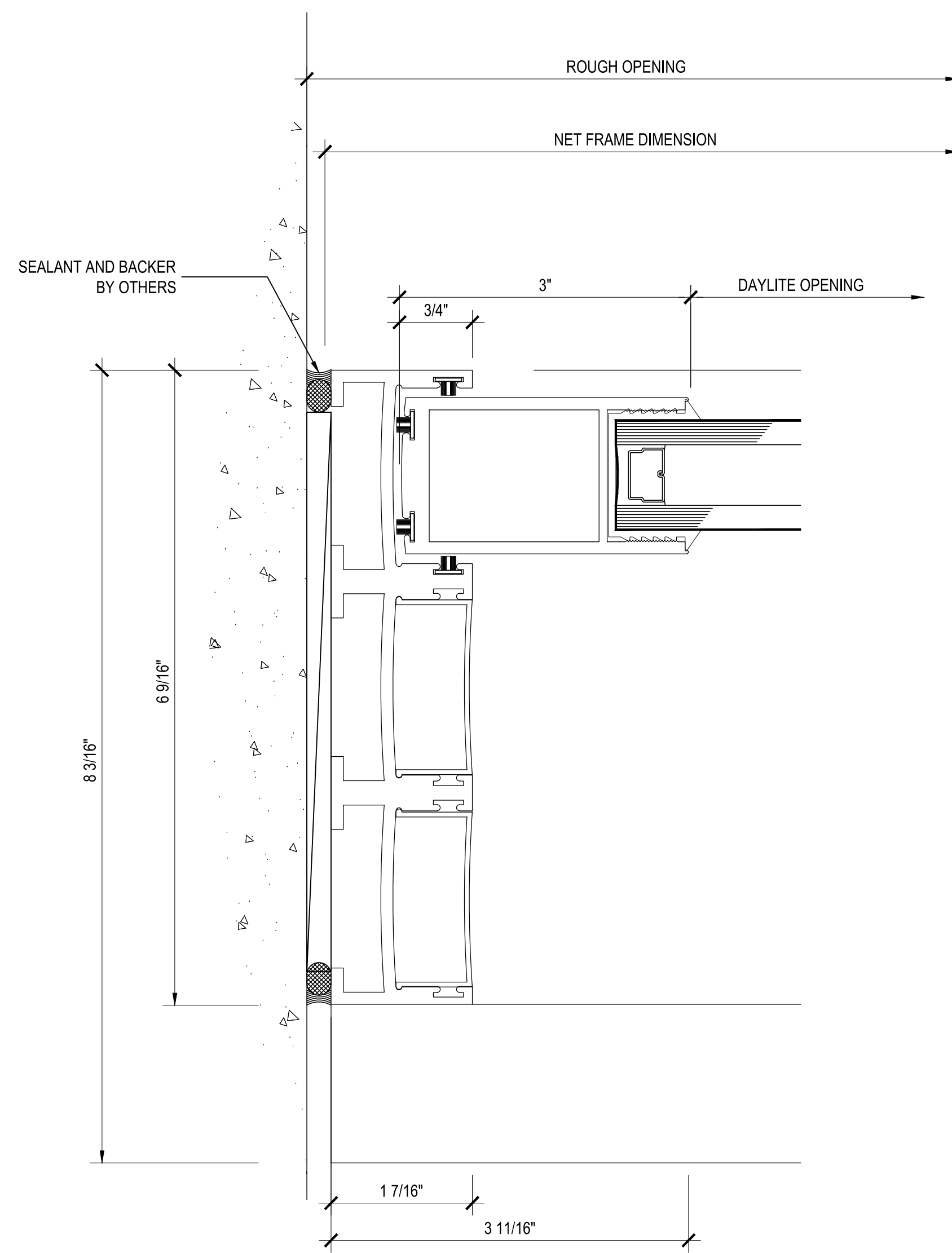

EXTERIOR

**A** Section @ Jambs  
Max-Slider Sliding Glass Door (XXO)

IMPORTANT DESIGN NOTE: ALL DECS, DESIGNS, ARRANGEMENTS AND PLANS INDICATED OR REPRESENTED BY THESE DRAWINGS ARE OWNED BY AND THE PROPERTY OF PRL GLASS SYSTEMS INC. NO PART THEREOF SHALL BE REPRODUCED, COPIED, ADAPTED, DISTRIBUTED TO OTHERS, PUBLISHED, SOLD OR OTHERWISE USED WITHOUT THE PRIOR WRITTEN CONSENT OF AND APPROPRIATE COMPENSATION TO PRL GLASS SYSTEMS INC. COPYRIGHT ©

ARCHITECT OF RECORD'S APPROVAL

STRUCTURAL ENGINEER OF RECORD'S APPROVAL

STRUCTURAL ENGINEER'S APPROVAL

GENERAL CONTRACTOR'S APPROVAL

REVISIONS	BY
▲	
▲	
▲	
▲	
▲	

job name  
job name  
job name  
address

GENERAL CONTRACTOR: XXXXXXXX ARCHITECT: XXXXXXXX

DATE: March, 21, 2014  
SCALE: XXXXX  
DRAWN: P  
JOB: XXXXXXXX  
SHEET

4.01

THIS DRAWING IS NOT TO SCALE IF NOT PRINTED ON 24" X 36" PAPER